

YSB761DG4C-LC

10G LC 1270nm/1330nm BOSA

Features:

- ◆ High-stability 1270nm DFB laser
- ◆ InGaAs PIN+TIA
- ◆ Built-in InGaAsP monitor photodiode
- ◆ Low threshold
- ◆ High reliability
- ◆ LC Receptacle



Application:

- Optical communication system

Specification:

Transmitter Characteristics	Symbol	Test	Min	Typ	Max	Unit
Nominal bit rate	-	-	-	10.3125	-	Gb/s
Rated Output Power	Pout	CW, Iop= Ith +20mA, Tc=25°C	0.5	-	0.85	mW
Threshold Current	Ith	CW, Tc=25°C	-	8	10	mA
		CW, Tc=-40~85°C	-	-	30	
Center Wavelength	λ	Iop= Ith +20mA, Tc=-40~85°C	1250	1270	1290	nm
Spectral Width	$\Delta \lambda$	Iop= Ith +20mA, Tc=-40~85°C, -20dB	-	-	1	nm
Operating Voltage	Vop	CW	-	-	1.6	V
Side Mode Suppression Ratio	SMSR	CW, Tc=-40~85°C	30	40	-	dB
Tracking Error	TE	Iop= Ith +20mA, Tc=-40~85°C	-1.5	-	1.5	dB
Rise and Fall times	Tr/Tf	20~80%	-	-	200	ps
Monitor PD Current	Im	Iop= Ith +20mA	50	-	1500	uA

Receiver Characteristics	Symbol	Test	Min	Typ	Max	Unit
Wavelength range	λ	CW, Tc=-40~85°C	1320	1330	1340	nm
Sensitivity	Sens	BER=10 ⁻¹² @10.3125G, ER=5dB, PRBS2 ³¹ -1	-	-	-16	dBm
Overload	P		0	-	-	dBm
Responsivity	R	λ =1330nm	0.7	-	-	A/W
Crosstalk	Xopt	λ =1270nm	-	-	-40	dB
Operating Voltage	Vcc	-	3.0	3.3	3.6	V
Operating Current	Icc	-	-	27	35	mA

产品名称: YSB761DG4C-LC

地址: 武汉市东湖新技术开发区华师科技园华师园 3 路 5 号

网址: www.ysod.com

电话: 027-67845125/6/7

Absolute Maximum Ratings:

Parameter	Symbol	Value	Unit
Forward Current (LD)	$I_{F(LD)}$	120	mA
Reverse Voltage (LD)	$V_{R(LD)}$	2	V
Operating Current (PD)	$I_{F(PD)}$	2	mA
Reverse Voltage (PD)	$V_{R(PD)}$	20	V
Operating Temperature	T_{OP}	-40 ~ +85	°C
Storage Temperature	T_{ST}	-40 ~ +85	°C
Lead solder temperature /duration	-	260/10	°C/S

Dimensions:

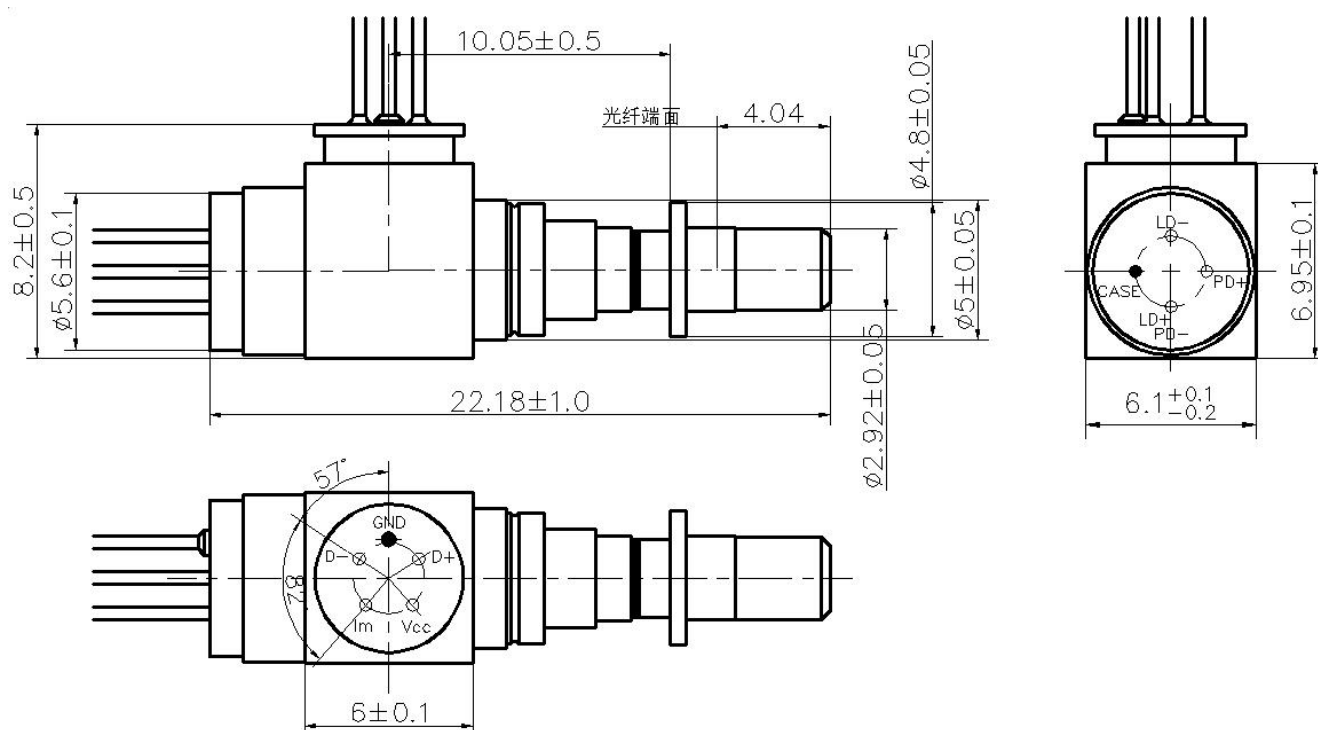

产品名称: YSB761DG4C-LC

地址: 武汉市东湖新技术开发区华师科技园华师园 3 路 5 号

网址: www.ysod.com

电话: 027-67845125/6/7